



AP 160N

Online UPS compact

- + Local Area Networks (LAN)
- + Servers
- + Data centers
- + Internet centers (ISP/ASP/POP)
- + Industrial PLCs
- + Emergency devices (light, alarm)
- + Medical devices
- + Telecommunication devices
- + Industrial application



Rack-tower convertible 1-2-3-6-10 kVA

AP160N Main Features

+ **COMPACT SOLUTION**

+ **LOWER POWER AUTO-CONSUMPTION**

+ **EXTENDABLE AUTONOMY**

+ **EXCELLENT RELIABILITY**

+ **HIGH POWER DENSITY**

+ **FLEXIBLE SETTINGS**



The high power density and the excellent reliability are the main features of the APN160N, the perfect solution for the critical loads, as servers and IT networks.

+ **EXCELLENT RELIABILITY**

- DSP (Digital Signal Processor) microprocessor controlling
- Rotary display with easy access
- Self-status monitoring and faults diagnosis

+ **HIGH POWER DENSITY**

- Wide input voltage range
- 0,9 load PF increase the power availability
- Input power factor correction for the lowest current distortion

+ **FLEXIBLE SETTINGS**

- Selectable configuration via LCD: online, Ecomode and frequency converter mode
- EPO connector for emergency power off

+ **COMPACT SOLUTION**

- Higher power performance in slim shape for 19" rack space
- Internal batteries easy replacement
- Connector for additional battery packs connection

+ **LOWER POWER AUTO-CONSUMPTION**

- High efficiency
- Ecomode operation available for efficiency up to 97%
- Low heating dissipation

+ **EXTENDABLE AUTONOMY**

- Solutions available with super charger for extended autonomy
- Dedicated battery packs for external batteries

1kVA to 3kVA

FLEXIBLE SETTINGS

- AC Output programmable management
- Configurable dry contact, available as standard

COMPACT SOLUTION

- 2U height with internal batteries up to 3kVA

LOWER POWER AUTO-CONSUMPTION

- High efficiency up to 90%

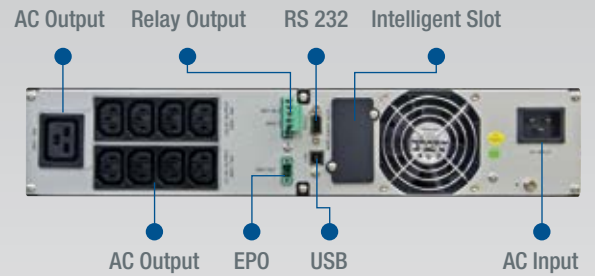

- MENU**
- UPS STATUS
 - BATTERY CAPACITY
 - LOAD LEVEL
 - INPUT/OUTPUT VOLTAGE

- INPUT/OUTPUT FREQUENCY
- FAULTS/WARNINGS
- SETTING MODE

6kVA

FLEXIBLE SETTINGS

- Redundant parallel 1+1 configuration
- Optional hot swappable PDU with mechanical maintenance switch, that allows to remove the UPS without loads switch off

COMPACT SOLUTION

- Just 3U height for 19" rack space with internal batteries
- Dual input, with separated bypass

LOWER POWER AUTO-CONSUMPTION

- High efficiency greater than 93%

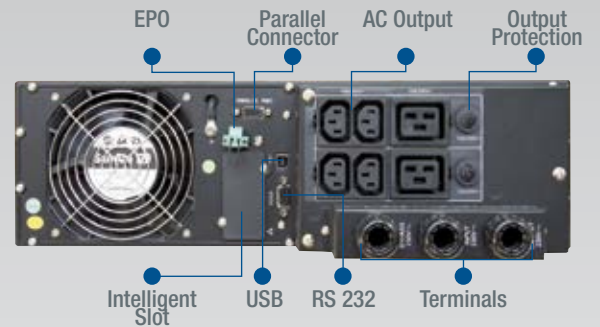

- MENU**
- UPS STATUS
 - BATTERY CAPACITY
 - LOAD LEVEL
 - INPUT/OUTPUT VOLTAGE

- INPUT/OUTPUT FREQUENCY
- FAULTS/WARNINGS
- SETTING MODE

10kVA

FLEXIBLE SETTINGS

- Redundant parallel 1+1 configuration
- Optional hot swappable PDU with mechanical maintenance switch, that allows to remove the UPS without loads switch off

COMPACT SOLUTION

- Just 5U height for 19" rack space with internal batteries
- Dual input, with separated bypass

LOWER POWER AUTO-CONSUMPTION

- High efficiency greater than 93%

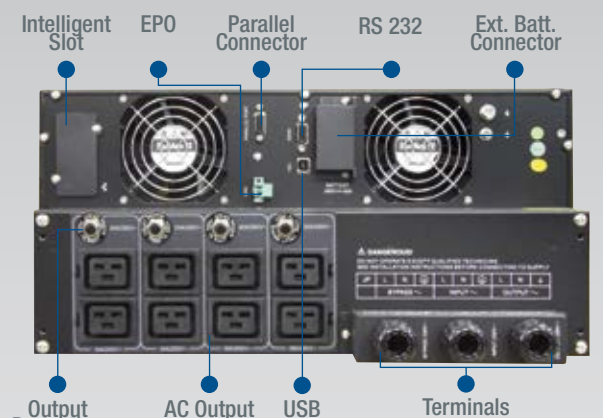

- MENU**
- UPS STATUS
 - BATTERY CAPACITY
 - LOAD LEVEL
 - INPUT/OUTPUT VOLTAGE

- INPUT/OUTPUT FREQUENCY
- FAULTS/WARNINGS
- SETTING MODE

Communications Solutions

Win Power CD comes together with UPS, which can also be downloaded from the Internet.

This software is able to:

- Remotely monitor and control the UPS
- Send alarm signals to the mobile phone
- Perform automatic shutdown of PC / server
- Schedule UPS self-test programs

This software provides complete protection to your system during power failure.

It supports most of the operating systems including Windows, Linux, 7/8/9 Sun Solaris, FreeBSD, IBM AIX 4.3x, 5.1x, and HP-UX 11.x.

In addition to this, to increase the benefits to our customers, we have released a version for MAC downloadable from the Internet.

Direct connection with Ethernet Network

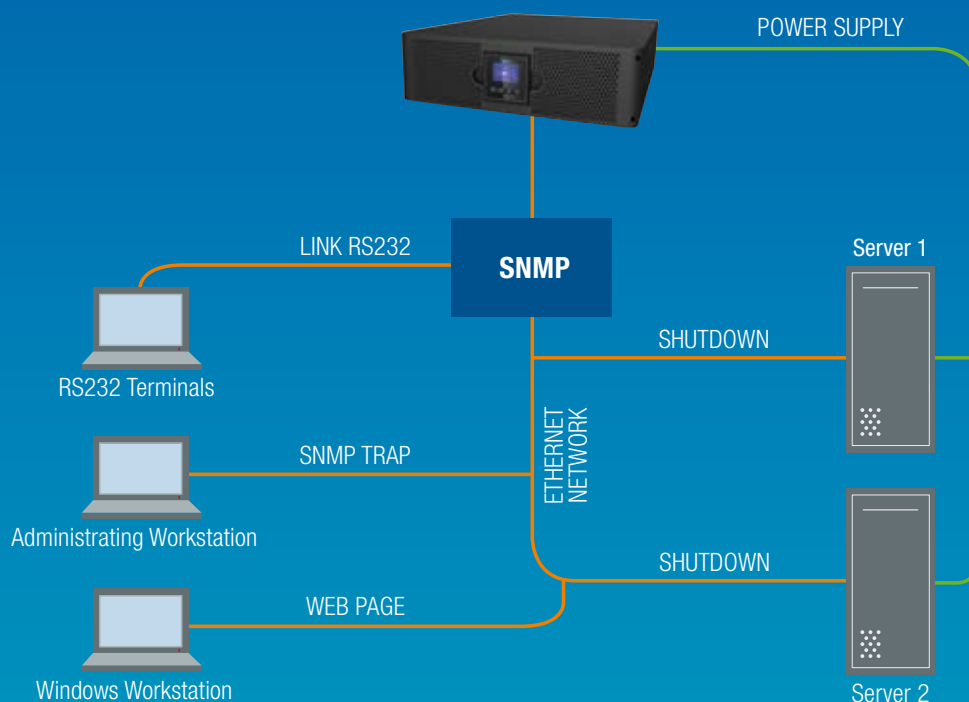

Interface Option



**AS 400N CARD
RELAY CARD**



MODBUS INTERFACE



SNMP CARD

- Power flow display for UPS status monitoring
- Scheduled system shutdown/restart
- Scheduled UPS tests
- Warnings notification via Email/Pager
- Warnings notification via Broadcast
- Security password protection
- Remote Monitoring / Control via LAN
- Multi-language versions: English, German, French, Italian, Spanish, Portuguese and Chinese
- Selectable user interface
- UPS parameters setting
- Recorded logs analysis
- The SNMP card allows UPS management across LAN using the main TCP/IP network communication protocols

UPS AP160N 6kVA up to 10 kVA in the parallel configuration allows the system to be flexible to the power expansion, and the redundancy increases the safety of continuity.

The feature of the redundancy in parallel provides a cheap solution for the system growth.

Moreover the parallel configuration splits equally the load to provide a higher level of continuity to your application.

Power Management

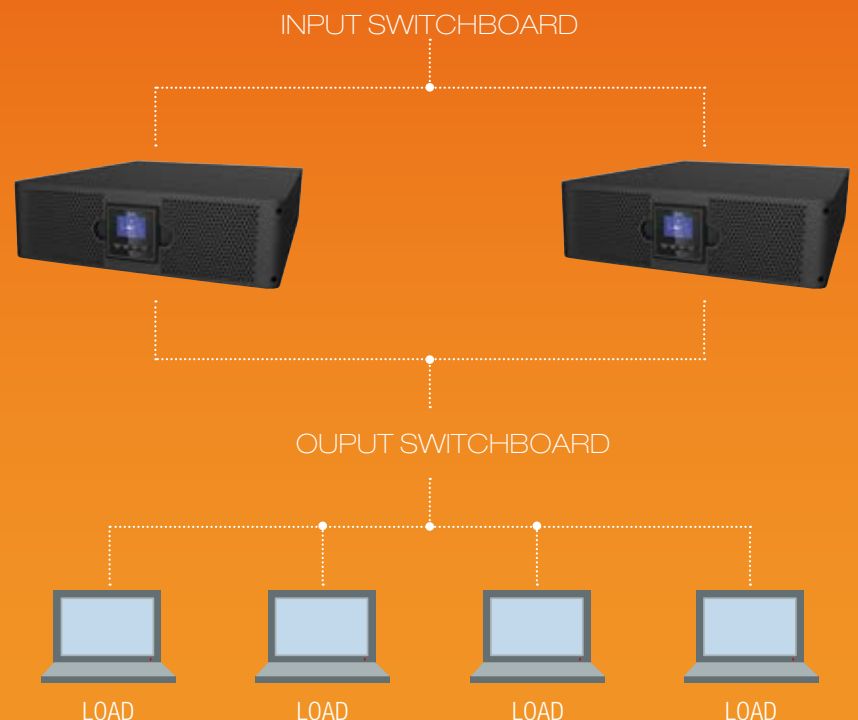

Benefits of the AP160N series

- The AP160N series represent the state of the art in technology on the mono-phase UPS category.
- Highest efficiency in its category even for reduced percentage of load due to the 3-level inverter IGBT technology.
- Extremely flexible to use with convertible rack / tower design and Online mode of operation, Ecomode, voltage and/or frequency converter.
- Top power density in its category due to reduced dimensions and Output $\cos\phi$ 0,9.
- Zero impact on the mains thanks to the PFC input which ensures THDi <5%, PF> 0.99.
- Complete solution and immediate use in small size, the UPS standard configuration has already on board installed batteries ready for use.
- Internal battery box can be easily removed thanks to the frontal access panel.
- Possibility to have autonomy even for several hours with the series AP160N-KS, provided with reinforced charger.
- Possibility to have manual bypass and function of parallel mounted to devices from 6 to 10 kVA.
- Essential aesthetic features that comply with modern concepts of design.

Green Technology

ENERGY SAVING

The high efficiency of the series AP160N is evident even for reduced percentages of the applied load. Its efficiency is due to the 3-level IGBT inverter, which represents the state of art in this category.

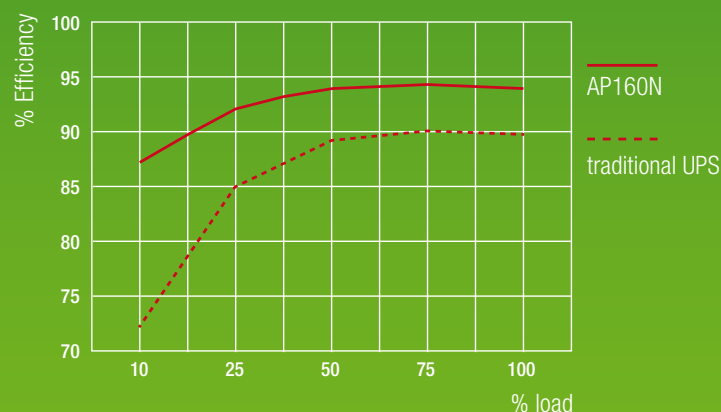

The extreme flexibility of use and superior performance even at reduced percentage of load allows the faster return of investment, compared to the majority of UPS in the market.

Technical Specifications

MODEL	AP160N	1K	1KS*	2K	2KS*	3K	3KS*	6K	6KS*	10K	10KS*
Power rating VA/W		1000VA/900W		2000VA/1800W		3000VA/2700W		6000VA/5400W		10000VA/9000W	
INPUT											
RATED VOLTAGE	220Vac / 230Vac / 240Vac										
VOLTAGE TOLERANCE	120 ÷ 276 Vac										
TRANSFER VOLTAGE RANGE	Based on load percentage 100% / 50%										
LINE LOW TRANSFER	176Vac (± 3%) / 120Vac (± 3%)										
LINE HIGH TRANSFER	276Vac (± 3%)										
FREQUENCY RANGE	45Hz÷55Hz / 54Hz÷66Hz										
THDI%	< 5% at full load										
POWER FACTOR	> 0.99 (I/P220Vac, full RCD load)										
OUTPUT											
RATED VOLTAGE	208Vac** / 220Vac / 230Vac / 240Vac										
VOLTAGE REGULATION	± 1%										
RATED FREQUENCY AC MODE	50/60 ± 0.2%										
CREST FACTOR (LPEAK/LRMS)	3:1										
HARMONIC DISTORTION	≤ 2% THD (Linear Load)										
OUTPUT WAVEFORM	Pure Sinewave										
POWER FACTOR	0.9										
BATTERY											
TYPE	Sealed lead acid battery										
RATING	12V/7.2Ah	36 Vdc depending on the capacity of external batteries	12V/9AH	48 Vdc depending on the capacity of external batteries	12V/9AH	72 Vdc depending on the capacity of external batteries	12V/5AH	180 vdc depending on the capacity of external batteries	12V/9AH	240 Vdc depending on the capacity of external batteries	
NUMBERS OF BATTERIES	3		4		6		15		20		
BACKUP TIME (TYPICAL LOAD)	> 3 minutes		> 3 minutes		> 3 minutes		> 2.5 minutes		> 3.5 minutes		
RECHARGE TIME	3 hours to 90%		3 hours to 90%		3 hours to 90%		3 hours to 90%		3 hours to 90%		
CHARGING VOLTAGE	41.1Vdc ± 0.6V		54.6Vdc ± 0.4V		81.9Vdc ± 0.4V		204.7Vdc ± 0.4V		273.0Vdc ± 0.4V		
GENERAL CHARACTERISTICS											
TRANSFER TIME (INVERTER TO BYPASS)	0ms										
DUAL INPUT TO BYPASS	N/A as standard									YES as standard	
PARALLEL CONFIGURATION	N/A						YES as optional				
EFFICIENCY (ONLINE MODE)	> 87%		> 89%		> 90%		> 93%				
DIMENSIONS (WXDXH) mm	438x435x2U		438x435x2U		438x560x2U		438x727x3U	438x676x3U	438x737x5U	438x676x5U	
WEIGHT (kg)	15.3	9.1	30.5	12.3	33.2	13.5	46.5	18.0	82.5	32.5	
OPERATING TEMPERATURE	0-40° C										
UMIDITY	0-95% (non-condensing)										
NOISE LEVEL (@ 1m)	<45dB		<50dB				<55dB				
INTERFACE STANDARD VIA SMART USB	WinPower Software supports: Windows 95/98/NT/2000/XP/ME, Linux, Sun Solaris, IBM Aix, Compaq True64, SGI IRIX, FreeBSD, HP-UX, and MAC										
INTERFACE FOR INTELLIGENT SLOT	SNMP /AS400N Card / Modbus all optional										
COMPLIANCE	IEC 61000-4, IEC 62040-1, IEC 62040-2, IEC 62040-3, IEC 60950-1, IEC 62040-1, ETS 300019-2-2 ***										

* KS means UPS with battery extra-charger and without internal batteries

** derate to 90% with 208Vac output voltage

*** It is recommended to refer to the product manual and regulations for installation on the site

Nota: product specifications are subject to change without further notice

G-Tec Service

G-TEC Service, our technical assistance facility uses highly trained engineers to provide a reliable support and after-sales service.

CALL CENTRE dedicated for connection to the G-TEC Service organisation. G-TEC Service personnel are always available and ready to provide advice and assistance regarding UPS installation, maintenance, fault finding and repair.

G-TEC Service can provide assistance during commissioning and startup of the UPS equipment on-site with additional training during handover to site personnel.

MAINTENANCE CONTRACTS can be provided by G-TEC Service to minimise respon-

se times and repair costs. Contracts range from periodic inspections to comprehensive cover including labour and materials.

FAST & READY: a fast repair on site is guaranteed through the use of state-of-the-art UPS technology, the professionalism of the UPS service personnel and Authorised Assistance Centres. UPS service guarantees that failed parts are replaced with original ones, tested and updated in order to maintain the safety, reliability and operating characteristics of the UPS.



www.gtec-power.eu

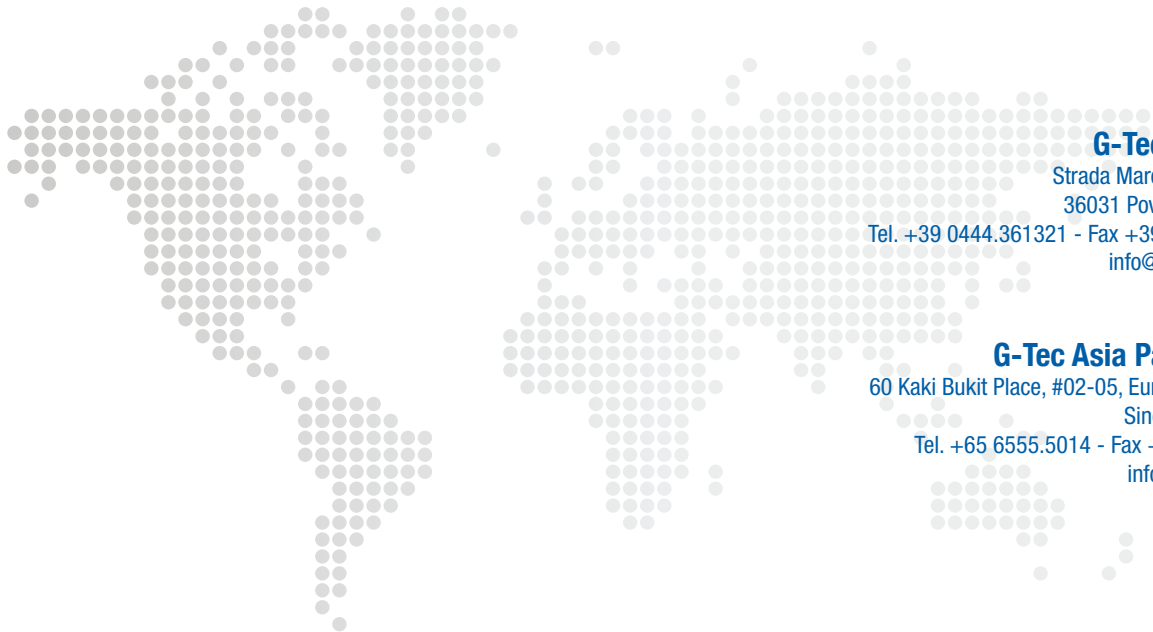

G-Tec Europe srl

Strada Marosticana, 81/13

36031 Povolara (VI), Italia

Tel. +39 0444.361321 - Fax +39 0444.365191

info@gtec-power.eu

G-Tec Asia Pacific Pte Ltd

60 Kaki Bukit Place, #02-05, Eunos Techpark II,

Singapore 415979

Tel. +65 6555.5014 - Fax +65 6555.4105

info@gtec.com.sg